

### Model HF6V-X

PLEASE READ ALL INSTRUCTIONS THOROUGHLY BEFORE PROCEEDING TO ASSEMBLY. DURING ASSEMBLY AND INSTALLATION TAKE EXTREME CARE TO AVOID CONTACTING POWER LINES WITH ANY PART OF THE ANTENNA OR OTHER CONDUCTORS.

DO NOT INSTALL THE ANTENNA IN ANY PLACE WHERE ANY PART OF IT CAN COME INTO CONTACT WITH POWER LINES IN THE EVENT OF STRUCTURAL FAILURE OF ANY PART OF THE INSTALLATION OR IN THE COURSE OF NORMAL FLEXING AFTER INSTALLATION, FOR SUCH CONTACT CAN RESULT IN DAMAGE TO PROPERTY, BODILY INJURY OR DEATH!

IN NO CASE SHOULD THE ANTENNA BE INSTALLED IN ANY PLACE WHERE STRUCTURAL FAILURE OF ANY PART OF THE ANTENNA OR ITS SUPPORTING SYSTEM CAN ENDANGER PERSONS OR PROPERTY.

CAUTION! A GROUNDED ANTENNA WILL BE AT DC GROUND POTENTIAL! TO AVOID DANGER OF SHOCK CONNECT ALL STATION EQUIPMENT TO A GOOD EARTH GROUND. IT IS ALSO RECOMMENDED THAT ALL STATION EQUIPMENT BE DISCONNECTED FROM THE POWER MAINS BEFORE CONNECTING THE FEEDLINE TO THE ANTENNA. PLEASE CONSULT THE A.R.R.L. HANDBOOK OR OTHER REFERENCE MANUALS FOR ADDITIONAL SAFETY PROCEDURES WHEN WORKING WITH ELECTRICAL EQUIPMENT.

Tools required for assembly: flat blade screwdriver, pliers and a knife. A set of nut-drivers will be useful.

#### ASSEMBLY

**TO ASSEMBLE AN HF9V-X, FOLLOW THESE INSTRUCTIONS, THEN INSTALL THE A-17-12 AND A6 ADAPTERS.**

NOTE: A small packet of anti-seize/anti oxide compound will be found inside mounting post A. This compound should be applied lightly to each tubing joint and to the inside of all clamps that must make good electrical contact with the tubing sections.

Refer to the appropriate drawings and diagrams and proceed as follows:

1. Check to be sure that all parts are present (see parts pictorial page.)
2. Locate tube A w/insulator (A). This is one of two lengths of 2' x 1 1/8" tubing that has a glass-epoxy insulating rod attached to it at one end. Tube a w/insulator (A) can be recognized by the long machine screw passing through the tube and the insulator. Do not confuse it with the piece of the same size and length that has the short machine screw.
3. If the antenna is to be installed at ground level, plant tube A w/insulator (A) in a hole approximately 21" (55cm) deep so that the upper end of the glass-epoxy insulator rod is approximately 5", 12 cm above ground level. Pack earth tightly around the mounting post so that it will remain vertical. Concrete may be used in areas of high winds for greater strength, in which case the post may be twisted slightly during setting for easy removal later. The mounting post tube should be protected

## ASSEMBLY

against corrosion if it is to be placed in concrete or damp, acidic or alkaline soil. Asphalt roofing compound, polyurethane varnish or any other sealant that protects against moisture may be used. No such protection is required for above-ground and most ground-level installations.

NOTE: hammering the mounting post into the earth may cause the insulator rod to splinter. If the post must be hammered into the earth, protect the end of the rod with a block of wood. If a permanent installation is not desired, a steel or other metallic tube having an inner diameter slightly larger than the outer diameter of tube A w/insulator (A) may be used, by inserting tube a w/insulator (A) into this outer tube for later removal. If the antenna is to be installed in an elevated position rather than at ground level, please refer to the note following Step 20 below, and to separate roof mounting kit/radial information. Use caution in handling the glass-epoxy insulators, for small splinters or flakes of this material may be present and cause irritation to sensitive skin. Above all, avoid rubbing the eyes after handling this material.

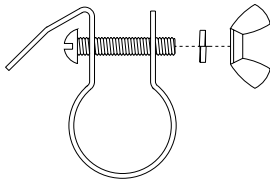
4. Prepare the coil Q base matching (Q) as shown in the pictorial drawing near the end of the instructions.
  5. Locate tube B1 section (B1) the extension tube on the parts page. This tube is 28" long and has a greater outer diameter, 1 1/4" than any other tube. Slide the unslotted end of this tube over the insulator at the top of tube A w/insulator (A), line up the holes and fasten it securely in place with a #8 x 2" machine screw, lockwasher and hex nut.
  6. Locate tube B2 w/insulator (B2). This is the other section of 2' x 1 1/8" tube, fastened to a glass-epoxy insulator by means of a short machine screw.
  7. Locate tube (B3). This is a 3' x 1 1/8" tube. Slide the unslotted end over the glass-epoxy insulator of tube B2 w/insulator (B2), line up the holes and fasten securely by means of 1 1/2" machine screw, lockwasher and hex nut. The completed sub-assembly of tube B2 w/insulator (B2) + tube (B3) may now be removed to a more convenient place where dropped hardware can be more easily recovered during the attachment of the 80 and 40 meter coils and capacitors.
  8. Locate coil assembly 80/40 meter (C) and slide the clamp at the outer end of the larger coil over the longer (upper) tube of the "B" sub-assembly, lowering the entire coil assembly until the middle clamp can be positioned around the glass-epoxy insulator rod. The middle clamp may have to be pulled open slightly to pass over the tubing and the bolt that goes through the upper tube and the insulator rod. Position the center coil clamp around the insulator rod so that the distance from the clamp to the end of either piece of tubing is approximately equal, and pass a #10 x 1" machine screw through the holes of the center coil clamp as shown in the drawing immediately below. The outer tab of this clamp may be bent back slightly to provide clearance for the bolt, and it may be bent back into place after final assembly. Fasten the center coil clamp firmly in place using a split lockwasher and a wing nut. Repeat the procedure for the two remaining coil clamps, tightening the wing nut only enough to hold the hardware in place. Coil adjustment will be made later.
- 
9. Locate the 80-40 meter capacitors, installed on a flat strip with a large center hole. Install the longer capacitor bracket 80 meter (D1) on the larger capacitor, using a #10 x 3/8" machine screw and lockwasher, see pictorial. Install the (smaller) capacitor bracket 40 meter (D2) on the smaller capacitor, using a #6 x 1/4" machine screw and lockwasher. **DO NOT OVER-TIGHTEN CAPACITOR MOUNTING SCREWS!**
  10. Line up the hole in the center of the capacitor strip with the threaded end of the long #10 machine screw protruding from the tab of the center coil clamp. Make sure that the capacitor bracket 80 meter (D1) runs alongside the larger, 80 meter coil of coil assembly 80/40 meter (C). Fasten the smaller center strip of capacitor assembly 80/40 meter (D) to the tab of the center coil clamp, using a flat washer, a split lockwasher and a #10 hex nut. Finally, fasten the tab end of the capacitor assembly firmly against the upper and lower tubes of "B" assembly by means of the two large non-adjustable

## ASSEMBLY

compression clamps. These clamps use a #8 x 1" machine screw, a split lockwasher and a hex nut. If a flat blade screwdriver is used to tighten the clamps do not grasp the work immediately opposite the blade in order to avoid injury if the blade slips.

11. Locate tubing sections tube E1 w/coupling (E1), tube (E2), tube (F), tube (G), tube (H), tube (I) and tube (J) as well as wire clamp 15M w/insulator (M) and wire clamp 15M w/insulator (N). Please note that as tubes are assembled the unslotted end of each tube will be pointing downward and the slotted end will be pointing upward. Slide wire clamp 15M w/insulator (M) over tube (G) and use the attached hardware to secure wire clamp 15M w/insulator (M) at the approximate center of the tube. Similarly, slide wire clamp 15M w/insulator (N) over tube (H) and tighten the hardware only enough to hold everything in place until final alignment of the 15 meter de-coupling stub.

IN THE FOLLOWING STEPS TUBES "E1" THROUGH "J" WILL BE FASTENED TOGETHER BY MEANS OF #8 HARDWARE, BOLT, SPLIT LOCKWASHER AND HEX NUT. AN 11/32" NUT DRIVER WILL BE USEFUL BUT NOT NECESSARY, IF A FLAT BLADE SCREWDRIVER IS USED DO NOT HOLD THE WORK IMMEDIATELY OPPOSITE THE BLADE IN ORDER TO AVOID INJURY IF THE BLADE SLIPS.

12. Slide one end of tube (E2) over the short smaller diameter tube emerging from the upper end of tube E1 w/coupling (E1), try both ends for best fit, align the holes, and pass a #8 x 1¼" machine screw through both tubes. Place a split lockwasher and a hex nut on the threaded end of the bolt and tighten snugly.
13. Insert the unslotted end of tube (F) into the slotted end of tube (E2) and proceed as in step 12, using a #8 x 1¼" machine screw and hardware.

Insert the unslotted end of tube (G) into the slotted end of tube (F) and proceed as in step 12.

14. Insert the unslotted end of tube (H) into the slotted end of tube (G) and proceed as before, using a #8 x 1" machine screw and hardware.
15. Proceed in the same way with the remaining tubes, using the remaining #8 hardware as needed. Note that a small adjustable hose clamp is provided for the slotted upper end of tube (I) to permit adjustment of tube (J).
16. Locate wire clamp 15M w/wire (L) and the attached length of stranded wire. Position the clamp around tube (I) so that its upper edge is approximately 8.5" (21.5cm) below the upper end of tube (I). Pass a #8 x ¾" machine screw through the clamp holes and secure firmly with a split lockwasher and a hex nut.
17. Locate wire clamp 15M w/insulator (K) and position it around tube (E2), using a #8 x 1" machine screw, split lockwasher and a hex nut. The plastic insulator at the end of wire clamp 15M w/insulator (K) should point upward.
18. Measure from the rivet of wire clamp 15M w/wire (L) to a point that is 11' 3" (3.43m) along the stranded wire. Mark this point for future reference.

19. Pass the free end of the stranded wire from wire clamp 15M w/wire (L) downward through the small holes in wire clamp 15M w/insulator (M) and (N) as shown in the illustration to the right. wire clamp 15M w/insulator (M) and (N) may be turned on their tubes so that they line up with wire clamp 15M w/wire (L). Loop the end of the wire through the hole in the plastic insulator of wire clamp 15M w/insulator (K) and slide it along tube (F) until the mark on the wire appears at the small hole in the insulator. Wind the wire back on itself above the insulator to keep the excess out of the way. Do not cut off the excess wire.

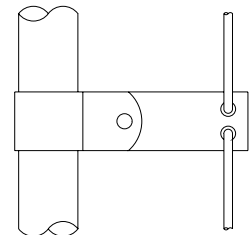

## ASSEMBLY

20. Line up wire clamp 15M w/insulator (K) with wire clamp 15M w/wire (L) and wire clamp 15M w/insulator (M) and (N). Position wire clamp 15M w/insulator (K) so that the wire is moderately taut but not so tight as to cause the upper tubing sections to bow. This completes assembly of tube E1 w/coupling (E1) through tube (J). These may be set aside for later installation atop (B) assembly.

NOTE: In the following steps the antenna will be assembled and raised to its full vertical height, after which the 30 meter tuning circuit will be installed. If the antenna is to be installed in an elevated position, rooftop, mast, tower etc., where it is unsafe or inconvenient to make in-place adjustments, the antenna may have to be installed in one piece, in which case it will probably be necessary to raise and lower it and its supporting structure a number of times to arrive at the "ideal" adjustment on all bands. If so, every precaution should be observed to avoid possible contact with power lines and to prevent structural failure that can cause injury to persons or property. **DO NOT USE U-BOLTS TO ATTACH THE TUBE A W/INSULATOR (A) TO A MAST, TOWER OR VENT PIPE OR OTHER SUCH SUPPORT, FOR U-BOLTS WILL EVENTUALLY CUT INTO THE TUBING AND WEAKEN THE INSTALLATION.** If, however, U-bolts must be used, place a larger diameter metal tube or other suitable protective material around the mounting post tube. Similar precautions should be observed when using TV-style towers with locking bolts. The Butternut Roof Mounting Kit (model RMK-II) includes a protective sleeve for the mounting post tube; this tube is also available separately as model MPS for non-permanent ground-level installations. And, always, **AVOID POWER LINES!!**

21. Take up the completed "B" assembly, both tubes, the 80/40 meter coils, capacitors and insert the 80 meter end, tube B2 w/insulator (B2) into the tube B1 section (B1) atop the tube A w/insulator (A).

Slide the completed "B" assembly into the tube B1 section (B1) so that the distance between the bottom of tube B1 section (B1) and the upper end of tube B2 w/insulator (B2) is 48 inches, see pictorial. Place a pencil mark at the point where the tube B1 section (B1) overlaps tube B2 w/insulator (B2).

The larger adjustable hose clamp may be placed over the upper slotted end of tube B1 section (B1) and tightened at this point, but that would mean that the tube E1 w/coupling (E1) through tube (J) assembly will have to be elevated and held with lower end some 7' above ground for insertion into the upper tube of "B" assembly.

If one does not have the reach or if high winds are a problem during installation it will probably be easier to install the completed "B" assembly as part of the assembly to be raised, in which case the "B" through "J" assembly need be raised only 30" or so above ground.

In either case, use a #8 x 1 1/2" machine screw, lockwasher and hex nut to attach tube E1 w/coupling (E1) to the upper tube of "B" assembly, tube (B3).

An overall vertical length of 26' from the feedpoint on the tube B1 section (B1) to the tip of tube (J) can be used for most ground-level dimensions, and tube (J) can be adjusted as needed for the sake of 10 meter tuning. Alternatively, a distance of 23' 8" may be measured from the tip of tube (J) to your pencil mark on the lower tube of section B to arrive at a preliminary length setting.

22. Locate coil support tube 30 meter (O) and the coil/capacitor assembly 30 meter (P). Coil support tube 30 meter (O) is the short tube with a tubular plastic insulator at one end. Note that the upper end of coil/capacitor assembly 30 meter (P) is connected to a double clamp assembly that includes a ceramic capacitor. Place a #10 split lockwasher and a wing nut on the bolt through the lower single clamp attached to coil/capacitor assembly 30 meter (P) and tighten just enough to hold the hardware in place. Locate the coil support tube 30 meter L bracket (O1). Fasten this clamp to coil support tube 30 meter (O) through the hole in the bottom using a #8 x 3/4" bolt, a split lockwasher and a hex nut.
23. Pass the lower clamp of coil/capacitor assembly 30 meter (P) over the insulator end of coil support tube 30 meter (O) and slide the coil downward along the tube until the upper edge of the upper clamp is flush with the end of the plastic insulator. Position the upper clamp so that the entire upper

## ASSEMBLY

assembly points in the same direction as the "L"-shaped clamp at the bottom of coil support tube 30 meter (O). Tighten the upper clamp around the insulator and set the completed coil support tube 30 meter (O)/coil/capacitor assembly 30 meter (P) assembly aside.

24. From the middle of the center clamp of coil assembly 80/40 meter (C), measure downward to a point that is 13" (33cm) along the lower tube B2 w/insulator (B2). Mark this point and stretch the 80 meter, larger coil until the lower edge of the bottom clamp is even with the mark. Tighten the wing nut to secure the clamp at this point.
25. From the middle of the center clamp of coil assembly 80/40 meter (C), measure upward to a point 9 3/8" (24cm) along the upper tube (B3). Mark this point and stretch the 40 meter, smaller coil until the upper edge of the upper clamp is even with the mark. Tighten the wing nut to secure the clamp at this point.
26. Take up the assembled 30 meter unit, coil support tube 30 meter (O)/coil/capacitor assembly 30 meter (P) and position the remaining upper clamp of this unit around the tube (B3) so that the L-bracket clamp from the lower end of coil support tube 30 meter (O) is even with the fourth turn, counting from the top down on the 40 meter coil. Use a split lockwasher and a hex nut to tighten this clamp a slight amount.
27. Hook the L-bracket clamp from coil support tube 30 meter (O) around the fourth turn of the 40 meter coil and use small #8 hardware to tighten the clamp securely around the coil. Adjust the position of the 30 meter unit along tube (B3) to avoid distorting the 40 meter coil. Tighten securely.
28. From the upper edge of the upper coil clamp on the coil/capacitor assembly 30 meter (P)/coil support tube 30 meter (O) measure downward to a point 9 7/8" (25cm) along coil support tube 30 meter (O) and mark this point with a pencil. Stretch the 30 meter coil until the lower edge of the lower clamp is even with this mark. Tighten the wing nut to secure the clamp at this setting. This completes the preliminary adjustment of the 80, 40 and 30 meter coils. Refer to the pictorial page.
29. Install the coax 75 ohm matching line (R) on tube A w/insulator (A) and tube B1 section (B1) as shown in the pictorial. Simply place the lugs over the ends of the #8 bolts at this time. The center conductor connects to tube B1 section (B1), the braid to tube A w/insulator (A).
30. Place #8 flat washers over the lugs and install coil Q base matching (Q) as shown. Point 1 should go to section (B), point 2 to tube A w/insulator (A) and point 3 to any ground rod or other earth connection. Secure the connection to tube A w/insulator (A) and tube B1 section (B1) with flat washers, lockwashers and hex nuts. Radials or additional grounding may be attached to the connection on tube A w/insulator (A) with the remaining #8 hardware.
31. **MAKE SURE THAT THE STATION EQUIPMENT IS CONNECTED TO A GOOD EARTH GROUND! DO NOT HANDLE ANY CABLE CONNECTED TO STATION EQUIPMENT WITHOUT FIRST DISCONNECTING THE EQUIPMENT FROM THE POWER MAINS. YOU COULD BE ELECTROCUTED!**
32. Connect coax 75 ohm matching line (R) to any length of 50-53 ohm coaxial cable. A PL-258 "barrel" connector (S) is provided. A small roll of weatherproof sealing tape has been provided. This may be used to seal the outside of the RF connectors that join the coax 75 ohm matching line (R) to the transmission line.

## CHECKOUT AND ADJUSTMENT

The dimensions and coil settings given above should produce reasonably low VSWR readings over the entire 10, 15, 20 and 30 meter bands and over at least 250 kHz of the 40 meter band. Bandwidth on 80/75 meters should be at least 30 kHz for VSWR of 2:1 or less, depending on the efficiency of the

## CHECKOUT AND ADJUSTMENT

ground system used, greater bandwidth being associated with lossy ground systems. It should be remembered that on those bands where the physical height of a vertical antenna is less than a quarter wavelength, the earth (or the resonant radial system in above-ground installations) will have a good deal to do with VSWR, antenna tuning, bandwidth, and overall performance.

Low VSWR by itself does not mean that a vertical antenna is operating efficiently, and if low VSWR is obtained with no more than the usual "quick and dirty" ground connection, it most likely means the opposite. In general, poor operation or improper tuning of vertical antennas can usually be traced to inadequate (or even reactive) ground systems or to other vertical conductors in the vicinity of the antenna. For these reasons it is suggested that the antenna be placed as much in the clear as possible and used with the best ground system that conditions permit. For a more complete discussion of the inter-relationships between vertical antenna efficiency, bandwidth, VSWR etc., a standard text such as the A.R.R.L. Antenna Book is recommended. Also review the material included at the end of these instructions.

For adjustment purposes a simple VSWR indicator may be used. More accurate measurements may be made at the antenna, i.e. at the junction of the 75 ohm matching line and the main transmission line, but the tuning conditions that exist at the transmitter will usually be of greater interest.

1. Determine the frequency at which VSWR is lowest on 80/75 meters. The coil settings given earlier should produce resonance and lowest VSWR at approximately 3700 kHz. To raise the frequency of resonance and lowest VSWR, simply loosen the wing nut on the lower coil clamp of the lower (80 meter) coil on section B and stretch the coil a bit more. To lower the frequency, compress this coil. A one inch change in the setting of this coil will produce a frequency shift of approximately 125 kHz. Remember that the antenna tunes very sharply in this range and that high values of VSWR may be encountered only a few kHz either side of the lowest VSWR readings. It would be wise to take VSWR readings every 25 kHz or so to avoid "running past" the frequency of resonance and lowest VSWR. To minimize interference to other stations and to avoid erroneous readings, use only enough power to produce full scale deflection of the meter in the "forward" or "R.F. out" position.

Once the proper coil setting has been found for the desired band segment, coil Q base matching (Q) at the base of the antenna may be adjusted for even lower VSWR. If earth losses are moderate to high, a good match may be possible if coil Q base matching (Q) is left fully compressed, if earth losses are low as with an extensive radial system, coil Q base matching (Q) may have to be stretched to twice its compressed length or more for a good match.

In any case, a single setting for coil Q base matching (Q) should suffice for operation over most of 80/75 meters provided the 80 meter coil is readjusted for each different band segment.

2. Determine the frequency of minimum VSWR on 40 meters. The coil setting given earlier should produce resonance and lowest VSWR at approximately 7150 kHz. The 40 meter VSWR and resonance curve may be shifted in the same manner as on 80/75 meters by changing the settings of the upper coil clamp of the 40 meter coil. On this band the setting is much less critical and a one inch change in the clamp setting will shift the VSWR curve approximately 80 kHz. Be sure to loosen the clamp around tube (B3) that supports the 30 meter assembly and to reposition it as needed to avoid distorting the 40 meter coil.
3. Check VSWR on 20 meters. Tuning is quite broad on this band because the antenna is physically much taller than a quarter wavelength. To raise the frequency of lowest VSWR, reposition the 30 meter assembly so that the L clamp can be replaced on the next lower turn of the 40 meter coil, refer to step 27 in the assembly instructions. Alternatively, to lower the frequency of lowest SWR, reconnect the L clamp to the next higher turn of the 40 meter coil. In some cases, moving the tap point a full turn up or down may cause more of a frequency shift than is desired, in which case the entire 30 meter assembly may be rotated to permit adjustments of less than one full turn.
4. Check VSWR on 15 meters. The VSWR curve may be shifted upward or downward by changing the

## CHECKOUT AND ADJUSTMENT

length of the stranded wire between wire clamp 15M w/wire (L) and wire clamp 15M w/insulator (K). To raise the resonant frequency, simply shorten the wire by wrapping a longer "tail" back on itself and sliding the lower clamp upward to maintain tension. To lower the resonant frequency, feed more of the "tail" back through the hole in the insulator to increase the length of the wire between clamps L and K. A change of 2", 5 cm will shift the VSWR curve approximately 300 kHz.

5. Check VSWR on 10 meters. To raise the resonant frequency loosen the small hose clamp over the slotted end of tube (I) and slide tube (J) farther into tube (I). To lower the frequency, slide tube (J) farther out of tube (I) and re-tighten the hose clamp. A length change of 3" should move the VSWR curve approximately 200 kHz.
6. Check VSWR on 30 meters. To raise the resonant frequency, loosen the wing nut on the bottom coil clamp on coil/capacitor assembly 30 meter (P), stretch the coil and re-tighten the wing nut. To lower the resonant frequency, compress the coil. A change of only 1/4" will shift the VSWR curve approximately 100 kHz. Large changes in the setting of coil on coil/capacitor assembly 30 meter (P) may effect 20 and 40 meter tuning, in which case it may be necessary to repeat steps 2 and 3. In general, the point at which the 30 meter coil taps on to the 40 meter coil will be the major factor in 20 meter tuning.
7. Adjustments for 40, 30, 20, 15 and 10 meters should have little or no effect on the previous adjustments for 80/75 meters, but final VSWR check for this band should be made as in step 1 above.
8. In above ground installations it will usually be found that resonance and lowest VSWR occur at slightly higher frequencies on all bands compared to ground level installations. Therefore, on 15 and 10 meters, where length adjustments is the means of setting antenna resonance, it is recommended that the length of the stranded wire between wire clamp 15M w/wire (L) and wire clamp 15M w/insulator (K) be increased approximately 3" (7.5cm) and that tube (J) be extended approximately 6" (15cm) beyond the original dimensions given if an above ground installation is contemplated.

These are merely recommended preliminary settings, for it is impossible to indicate precise settings that will produce resonance or lowest VSWR at a given frequency in all installations.

In the preceding steps it has been assumed that the antenna has been installed in a more or less clear spot away from other vertical conductors such as TV antenna feedlines, towers and masts, and that a minimal ground system or a system of resonant radials in the case of above ground installations, has been installed.

If these fairly basic conditions have not been met it is likely that resonance and low VSWR will be impossible on some or even all bands without an external matching device. One should bear in mind that VSWR, even with a resonant antenna, will depend in large measure on local ground conductivity, height above ground in the case of an elevated antenna, the extent of the radial, counterpoise or other ground system used, and on other factors over which the operator may have little or no control.

## THEORY OF OPERATION

The HF6V-X / HF9V-X operates as a slightly extended quarter-wave radiator on 15 meters, a quarter-wave stub decoupler providing practically lossless isolation of the upper half of the antenna on that band. On 20 meters the entire radiator operates as a 3/8 wave vertical with much higher radiation resistance and VSWR bandwidth than conventional or "trapped" antennas having a physical height of on quarter wave or less. On 10 meters the HF6V becomes a 3/4 wave radiator with considerably greater radiation resistance and efficiency than quarter-wave trapped types. On 40 and 80/75 meters the L-C circuits that provided the inductive reactance for resonance on those bands also provide the capacitive reactance required for resonance on 20 meters.

On 30 meters, where the height of the antenna is slightly greater than a quarter wavelength, an additional L-C series circuit effectively "shorts out" a portion of the 40 meter inductor to provide an additional

## THEORY OF OPERATION

resonance.

In order to minimize conductor and IR losses on 80 and 40 meters where the antenna is physically shorter than a quarter wavelength and thus operates with lower values of radiation resistance, large diameter self supporting inductors and low loss ceramic capacitors are employed.

Because the 20 meter radiation resistance is several times greater than that of conventional "trap" designs of the same height, an electrical quarter wavelength of 75-ohm cable is used as a "geometric mean" transformer to match the approximately 100 ohms of the 20 meter feedpoint impedance to a 50-ohm feedline of any convenient length.

If operation is desired on 160 meters, the 17 and 12 meter bands, or even 6 meters, add-on kits requiring no "surgery" are available from your Butternut dealer. NOTE: The A-17-12 and A-6 adapters are provided with the HF9V-X.

### ELECTRICAL AND MECHANICAL SPECIFICATIONS

Shipping weight:	12 lbs/5.4 kg (HF6V-X)	14 lbs/6.4 kg (HF9V-X)
Height (adjustable):	26 ft/7.8 m	
Feedpoint impedance:	nominal 50 ohms with included matching line	
SWR at resonance:	1.5 or less—all bands	
SWR bandwidth for 2:1 or less:	entire 10, 15, 20 and 30 meter bands; 250-300 kHz on 40 meters, 30-100 kHz on 75/80 meters	
Power rating:	1500 watts PEP 80-10 meters; 400 w PEP on 30 meters	
Wind loading area:	1.5 sq ft/0.15 sq m	

### GUYING

The antenna is designed to survive winds of up to 80 mph/125 kph without guying given the absence of ice-loading or heavy wind driven rain or sleet. In areas of frequent heavy winds a set of SHORT guys can be used to reduce the stresses that wind loading will impart to the lower sections of the antenna.

It should be noted that light nylon twine is totally unsuitable as guying material because it has too much stretch per unit length, although the heavier sizes of nylon rope (or even sash cord) may be suitable if used in short runs. Polyethylene rope may be used, but because some grades tend to deteriorate fairly rapidly, periodic inspections should be made.

A single set of guys placed just above the 30 meter circuit will be quite effective, provided that the guys retain a slight amount of slack and do not come off at too steep an angle. At angles of less than 45° the guys begin to exert a downward compressive force on the structure that can be more of a threat to survival than lateral wind loading on an unguyed structure.

Under no circumstances should guys be placed higher than 1/3 of the way up the antenna. The upper 2/3 of the antenna has little more than its own weight to support, so these sections may be allowed to bend with the wind with no serious risk of damage. It is the lower 1/3 of the antenna that must support both the weight of the upper sections and the wind loading on them and are thus more likely to receive damage in severe winds.



## NOTES ON GROUND/RADIAL SYSTEMS FOR VERTICAL ANTENNAS

### GROUND MOUNTING

A vertical antenna in its simplest form is electrically equivalent to one-half of a dipole antenna stood on end. When the antenna is mounted close to the ground, the earth below takes the place of the "missing" half of the dipole. If ground conductivity is fair to good, a short metal stake or rod may provide a sufficiently good ground connection for resonant and low SWR operation on the bands for which the antenna is designed. This basic arrangement is shown in figure one. In most every case, however, the efficiency of a vertical antenna will be greater if radial wires are used to improve ground conductivity as in figure two. Wire size is unimportant, and, in most ground-mounted installations, the radials may be any convenient length. They need not all be the same length, nor do they all need to be laid in a straight line. It is generally more convenient to slit the sod and to push the radials into the slits to a depth of several inches, but they may be left on the surface of the ground if they do not constitute a hazard. A large number of long radials will naturally be more effective in reducing ground losses than a small number of shorter ones, but one should remember that the greatest loss will occur in the earth near the base of the antenna where current flow is greatest. For this reason, it is generally better to use a larger number of radials of shorter length than a smaller number of longer ones for a given amount of wire.

In some cases wire mesh (e.g., "chicken wire") may be used as a substitute for radial wires and/or a ground connection, the mesh or screen acting as one plate of a capacitor to provide coupling to the earth beneath the antenna.

It should be noted that A GROUND ROD IS USEFUL ONLY AS A DC GROUND OR AS A TIE POINT FOR RADIALS. IT DOES NOTHING TO REDUCE RF GROUND LOSSES, REGARDLESS OF HOW FAR IT GOES INTO THE GROUND!

### ABOVE GROUND MOUNTING

It is possible to operate a vertical antenna at any height above ground provided that something is done to supply the equivalent of a ground connection. It is NOT ENOUGH TO RUN A LONG LEAD TO A GROUND ROD OR COLD WATER PIPE, for current will flow in the lead, making it part of the overall antenna length and detuning the antenna. The usual approach to this problem is to install three or four resonant quarter-wave radials at the base of an elevated vertical and to connect them to the braid of the coaxial feedline as well as to the supporting mast or tower (if metal). Unlike the ground-mounted case, length of above ground radials is important, and the proper length(s) for any band may be found from the formula:

$$Length(ft) = \frac{240}{Frequency\ in\ MHz}$$

Four such radials, equally spaced, would be the equivalent of a highly conductive ground plane for any band at antenna base heights of one-half wavelength or more. In addition to providing a ground plane, radials of the proper length act as decoupling stubs to choke off current flow on any DC ground lead or grounded mast or tower, thus eliminating the detuning effect noted above. The basic ground plane system is shown in figure three. Radials may be run parallel to the earth or sloped downward any convenient amount without seriously affecting antenna feed point impedance or performance. Figure four shows a multi-band system using four separate sets of radials for 40, 20 and 10 meters. Inasmuch as the 40 meter radials are also resonant on 15 meters, a separate set is not required for that band. This same system will provide enough capacitive coupling to ground for operation on 75/80 meters at antenna base heights below about 40 feet in some cases, but since ground conditions vary widely, it is advisable to use at least one resonant 80 meter radial in an above-ground installation.

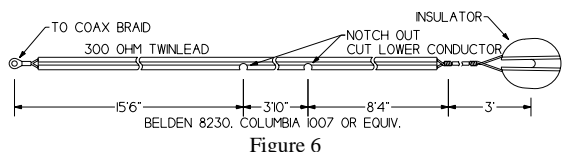

Figure 6

Figure five shows a simpler system which uses a single resonant radial for 80/75, 40, 30, 20, 17, 12 and 10 meters. With this arrangement, the antenna resembles a bent dipole on any one band, and the radiation pattern contains both horizontal and vertical components. The system in figure four, however, produces omnidirectional vertically polarized radiation. (Note: 30, 17 and 12 meter radials are not shown, but may be included in this type of system.)

Figure six illustrates the construction of a multi-band radial which is resonant on 40, 20, 15 and 10 meters. Good quality 300 ohm TV ribbon lead should be used (velocity factor is critical), and the conductors should employ at least one strand of steel wire to support the weight of the radial. Four such radials will be the practical equivalent of the system shown in figure four for operation on 80 through 10 meters.

Regardless of the specific system used, radials should be well insulated at their far ends and kept clear of large masses of metal or other conductors that could cause detuning.

### OTHER MOUNTING SCHEMES

In cases where a resonant vertical antenna may be neither ground mounted nor used with an elevated ground plane, operation may still be possible if connection may be made to a large mass of metal that is directly or capacitively coupled to ground, e.g., central air conditioning systems or structural steel frames of apartment buildings. Some amateurs have reported good results with vertical antennas extended horizontally or semi-vertically from metal terraces which serve as the ground connection. Alternatively, a quarter-wave vertical may be window mounted if a short ground lead to a cold water pipe or radiator can be used. If a long lead must be used, tuned radials will be required for resonance on one or more bands. GREAT CARE SHOULD BE EXERCISED IN SUCH INSTALLATIONS TO AVOID POWER LINES AND TO KEEP THE ANTENNA FROM FALLING ONTO PERSONS OR PROPERTY.

The metal shells of camper trailers, vans and mobile homes may also be used as ground systems for vertical antennas. Whenever possible, the antenna should be mounted with its base close to the top of the roof, and the shortest possible ground lead should be used. Even so, tuned radials may be required for low SWR on one or more bands.

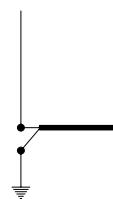

Figure 1

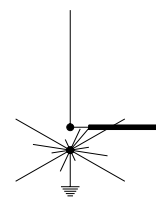

Figure 2

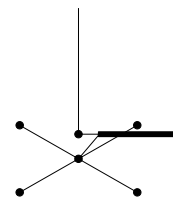

Figure 3

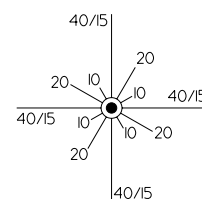

Figure 4

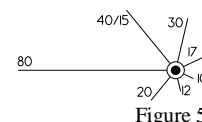
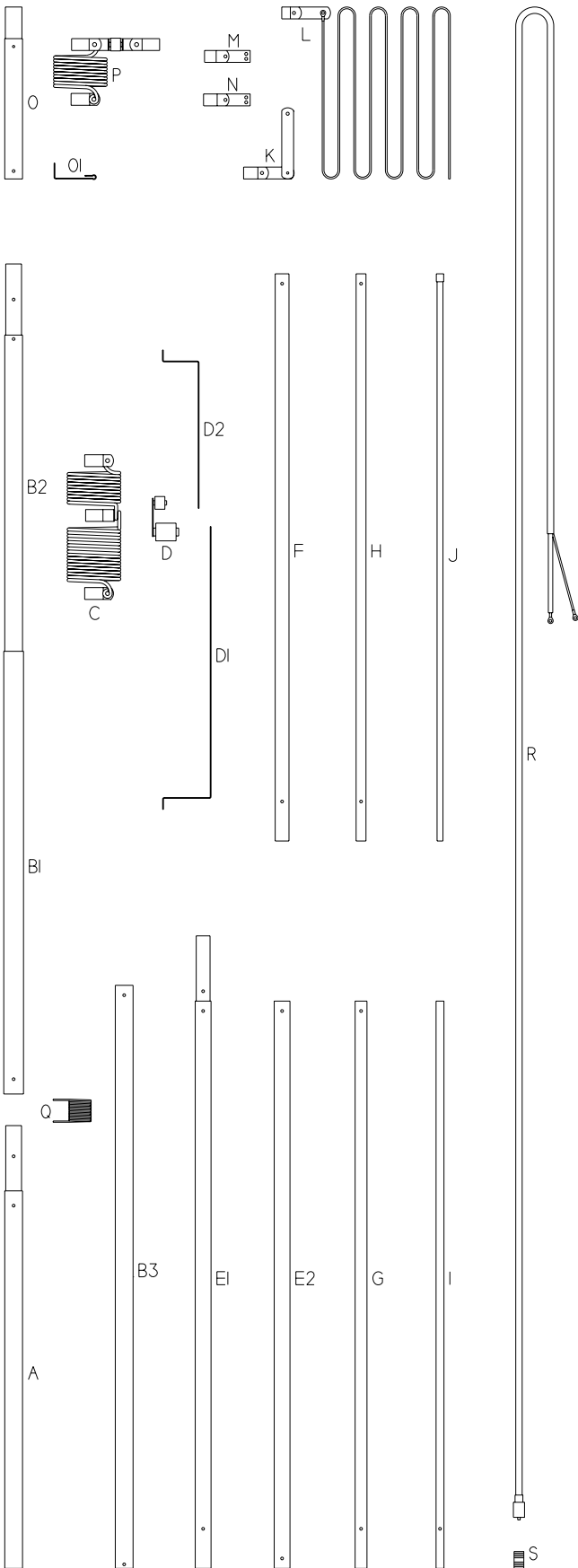

Figure 5

# PARTS LIST



- A V00278 Tube A W/Insulator, 1 1/8" X 24"
- B1 V00285 Tube B1 Section, 1 1/4" x 28"
- B2 V00297 Tube B2 W/Insulator, 1 1/8" x 24"
- B3 V00167 Tube B3, 1 1/8" x 36"
- C V00145 Coil Assembly 80/40 Meter
- D V00190 Capacitor Assembly 80/40 Meter
- D1 V00150 Capacitor Bracket 80 Meter
- D2 V00220 Capacitor Bracket 40 Meter
- E1 V00284 Tube E1 W/Coupling
- E2 V00170 Tube E2, 1" x 36"
- F V00171 Tube 0.875" x 36"
- G V00172 Tube 0.750" x 36"
- H V00173 Tube 0.625" x 36"
- I V00174 Tube 0.500" x 36"
- J V00175 Tube 0.375" x 36"
- K V00286 Wire Clamp 0.875" 15M W/Insulator
- L V00280 Wire Clamp 0.500" 15M W/Wire
- M V00281 Wire Clamp 0.625" 15M W/Insulator
- N V00282 Wire Clamp 0.750" 15M W/Insulator
- O V00204 Coil Support Tube 30 Meter
- O1 V00176 Coil Support Tube 30 Meter L Bracket
- P V00249 Coil/Capacitor Assembly 30 Meter
- Q V00137 Coil Q Base Matching
- R V00223 Coax 75 Ohm Matching Line
- S V00228 Connector PL-258

## HARDWARE

- 4 V00077 # 8 x 3/4" Screw
- 5 V00078 # 8 x 1" Screw
- 5 V00079 # 8 x 1 1/4" Screw
- 3 V00114 # 8 x 1 1/2" Screw
- 2 V00109 # 8 x 2" Screw
- 7 V00083 # 8 Flat Washer
- 20 V00080 # 8 Lock Washer
- 20 V00081 # 8 Hex Nut
- 2 V00131 #10 x 1" Screw
- 6 V00132 #10 Flat Washer
- 8 V00133 #10 Lock Washer
- 4 V00134 #10 Hex Nut
- 5 V00135 #10 Wing Nut
- 2 V00143 Capacitor Bracket Clamp
- 1 V00195 Large Adjustable Compression Clamp
- 1 V00144 Small Adjustable Compression Clamp
- 1 V00061 Butter-It's-Not
- .05 V00050 Konnektor-Kote (1 x 8")

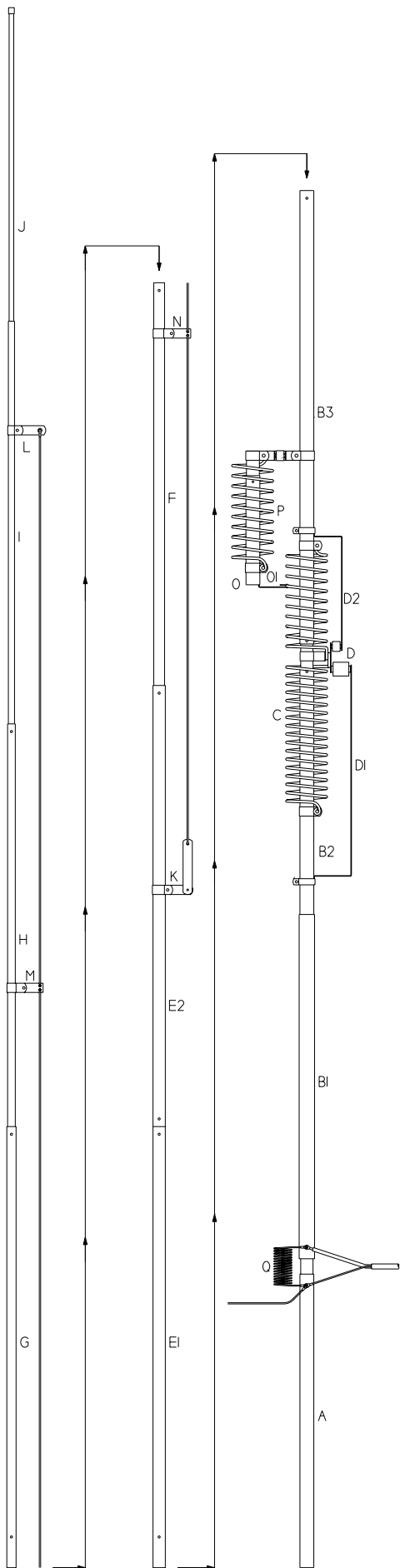

### Feedline Detail

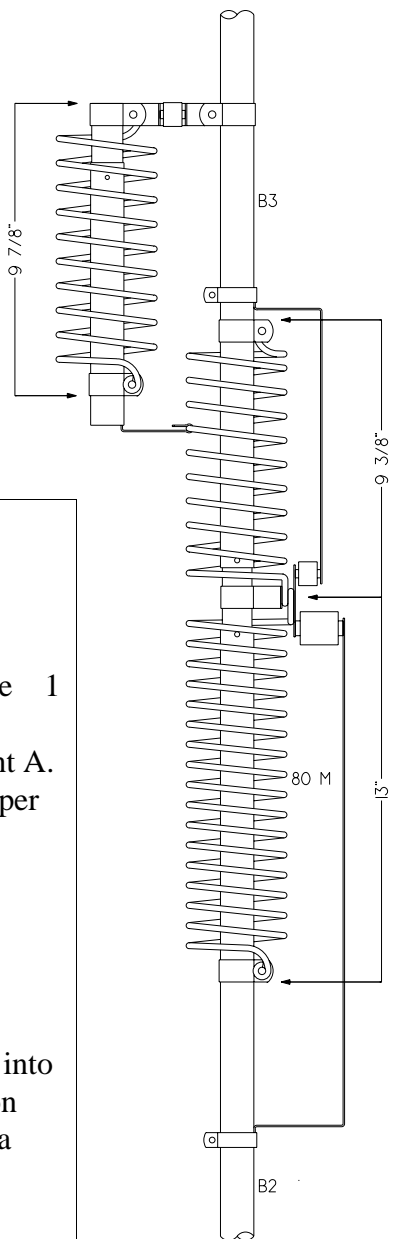
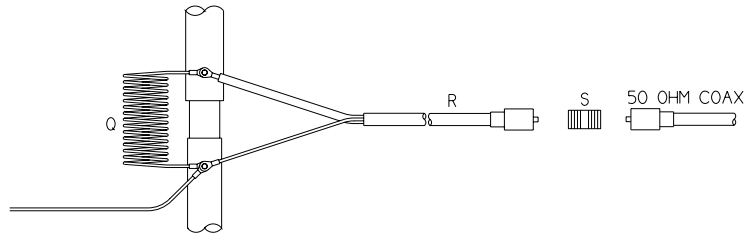

1. Use a knife to scrape 1 1/2" of enamel insulation from point A. Be sure that the copper is bright and clean.
2. Bend the clean area into a loop for connection later. The clean area may be tinned with solder.

## IF YOU HAVE PROBLEMS...

Check out your installation again, looking for loose connections and checking all dimensions. Then refer to the list of possible symptoms below:

- Symptom: Few or no signals heard: bands seem "dead", SWR is very high.  
 Look for: Open or shorted feedline, open or shorted matching line, broken connection at base of antenna (feedpoint).
- Symptom: High SWR on 20m; other bands OK.  
 Look for: Missing matching line. Antenna not properly tuned. 20m radials not present or wrong length. Consult instructions for tuning and radial information; install matching line (RG-11 75 ohm coax, 11' 4" if solid dielectric, 13' 6" if foam type).
- Symptom: High SWR on some bands, but signals heard on all bands (conditions permitting).  
 Look for: Missing or defective radial system. Install as per instructions and check connections to radials and ground system. Keep this connection 6" or less.
- Symptom: High SWR on one band when antenna is roof-mounted. Radials are in place, but antenna will just not tune.  
 Look for: Radials of wrong length or running close to metal rain gutters or roof flashing. Tune radials and/or reroute them away from metal.
- Symptom: Tuning is "sharp" with narrow bandwidth on 80m (and 160m if TBR 160 is in place).  
 Look for: Normal condition. The total length of the antenna represents such a small percent of a wavelength on these bands that sharp tuning is a normal condition.
- Symptom: Antenna was installed on the ground and tuned OK, but tuning changed over a period of weeks or months.  
 Look for: Antenna installed over poor ground system. Ground conditions have changed, causing shift in resonance. Install radial system as per instructions. Check connection to radial system. When you see this problem, you may assume that a ground rod without a radial system is not enough.
- Symptom: Resonant point changes during wet weather.  
 Look for: Normal condition.
- Symptom: Insulation arcs over between 80m and 40m coils damaging fiberglass.  
 Look for: Operation at high power levels in areas where salt or pollution deposits have built up on the insulators. The cure is to keep insulators clean through routine maintenance.
- Symptom: Intermittent operation. SWR jumps up and down suddenly, and reception is also intermittent.  
 Look for: Loose connections in the feedline or matching line (if used). Bad relay in rig. Bad antenna switch or connecting cable. Broken or corroded connections at the feedpoint. Bad radial/ground connection. Radial or antenna contacting metal when wind blows. Loose hardware on the antenna. Check and secure all connections.
- Symptom: Antenna displays generally degraded performance after long period of time.  
 Look for: Lack of routine maintenance. Coax may be waterlogged or damaged. Build up of salt or pollution deposits on insulators and capacitors. Radial system corroded or rotted away. Owner must do routine maintenance at intervals, according to local conditions.
- Symptom: SWR is OK on 75m, but goes up gradually when high power is applied. This is accompanied by heating of 200pF capacitor.  
 Look for: Bad ceramic capacitor. Replace.
- Symptom: Antenna doesn't tune 80m or 160m, even though radials are in place and of proper length.  
 Look for: Antenna far out of tune; operator has not followed systematic tuning procedure. Start with suggested settings in instructions. Make an SWR chart to determine point of resonance. Adjust coils *carefully!* Remember, tuning, is "sharp" on these bands, so it is easy to pass the resonant point, then assume erroneously that the antenna isn't tuning.

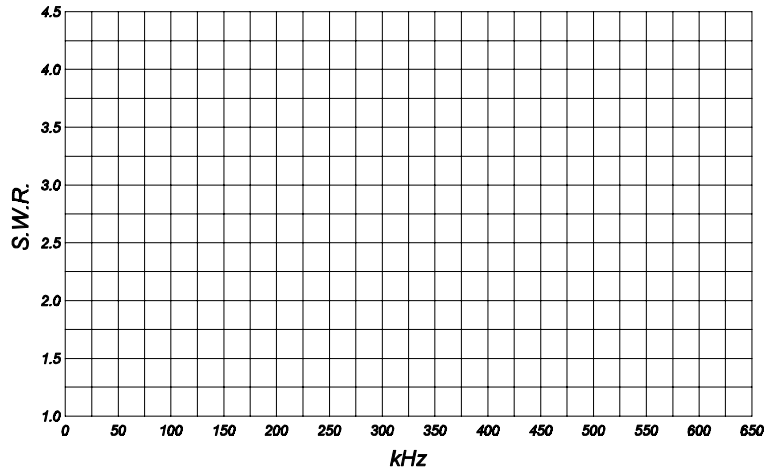

BEFORE you call the manufacturer for help, please double check your installation, including all connections and dimensions. Tune carefully and systematically. Have SWR curves available. Be prepared to describe your installation in detail.